

STONE ANCHORS

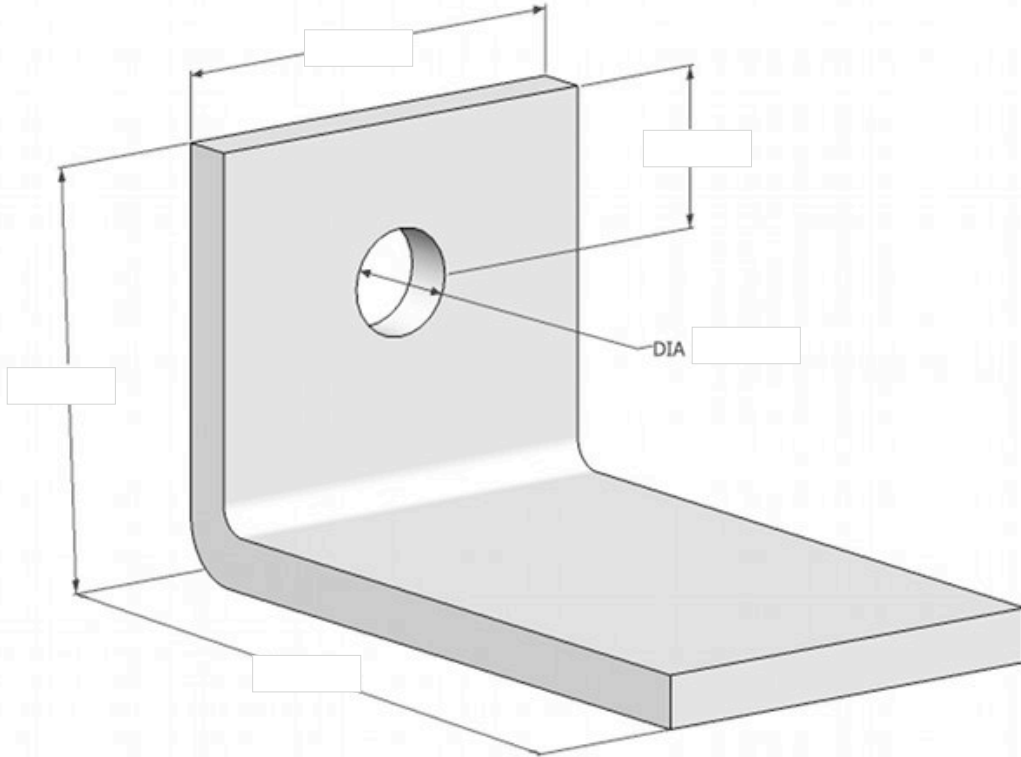

#3058 "L" Anchor



QUANTITY: _____

ST/ST Min. Fy = 45,000 p.s.i (ASTM A666)

THICKNESS:

- 1/8" 1/4"
 3/16" Other _____

FINISH:

- Hot Dip Galv.
 Stainless Steel Type 304



CONTACT INFORMATION:

Name: _____
Company: _____
Phone: _____ Fax: _____
E-mail: _____

PROJECT INFORMATION:

Name: _____
Location: _____
